

Broadband Fast Fiber Optical Shutter

(US patent 8,666,218 and other patents pending)



DATASHEET

BUY NOW

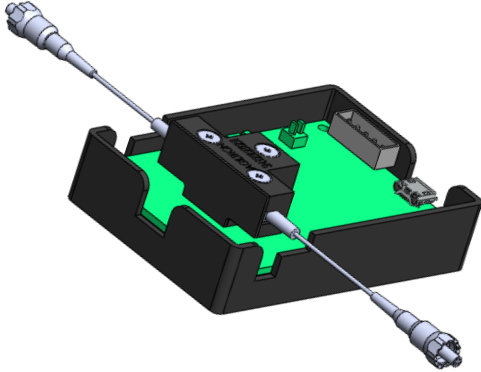

Features

- 0.2dB Low Loss
- 0.1dB Repeatable
- 300-2100 Broadband
- 65dB Attenuation
- SM,PM,MM

Applications

- Power Control
- Power Regulation
- Channel Balance
- Instrumentation

The Ultra-Broadband Fast Fiber Optical Shutter is based on a micro-electro-mechanical system (MEMS) fiber-to-fiber direct coupling platform driven by a fast piezo actuator. It uniquely offers fast shut-off speed of 0.5ms and near-perfect performances that are unmatched in the industry, including ultra-low insertion loss of 0.2dB, ultra-broadband from 200 to 2100nm, high blocking level >65dB. Light passes through the device with a thin index-matched gap without any optical coatings. It is available with all types of fibers having a 125 micron outer diameter. Other diameter fibers can be accommodated with special order.

The Shutter is integrated with a PCB with a USB with GUI software and four sub-mount pins: two for 0-5V DC power input and two for 0-5V control input.

Specifications

Parameter	Min	Typical	Max	Unit
Operation Wavelength	300		2500	nm
Insertion Loss ^[1]	0.01	0.4	0.5	dB
Response Time	0.5		15	ms
Repetition Rate			20	Hz
Polarization Dependent Loss ^[2]		0.15	0.5	dB
Wavelength Dependence Loss ^[2]		0.1	0.2	dB
Attenuation Range		60	80	dB
Extinction Ratio (PM version only)	18	23	25	dB
Polarization Mode Dispersion (SM version only)		0.01	0.05	ps
Return Loss	50			dB
Response Time		0.3	0.5	ms
Optical Power handling (CW) ^[3]		500	600	mW
Operating Temperature	-10		75	°C
Storage Temperature	-40		85	°C

Notes:

- [1]. Without connector and at room temperature
- [2]. At attenuation less than 20 dB
- [3]. For SM 28 fiber, small core power handling reduced

Note: The specifications provided are for general applications with a cost-effective approach. If you need to narrow or expand the tolerance, coverage, limit, or qualifications, please [\[click this link\]](#):

Warning: The device mounted on the PCB is an OEM module designed for system integration only, not for general uses. Do not touch the PCB by hand. The electrical static can kill the chips even without a power plug-in, and unpleasant electrical shock may also be felt. For laboratory use, please buy a protected Turnkey system.

Legal notices: All product information is believed to be accurate and is subject to change without notice. Information contained herein shall legally bind Agiltron only if it is specifically incorporated into the terms and conditions of a sales agreement. Some specific combinations of options may not be available. The user assumes all risks and liability whatsoever in connection with the use of a product or its application.

Rev 08/09/24

Broadband Fast Fiber Optical Shutter



(US patent 8,666,218 and other patents pending)

DATASHEET

Mechanical Footprint Dimensions (Unit: mm)

A: Fast shutter with driver

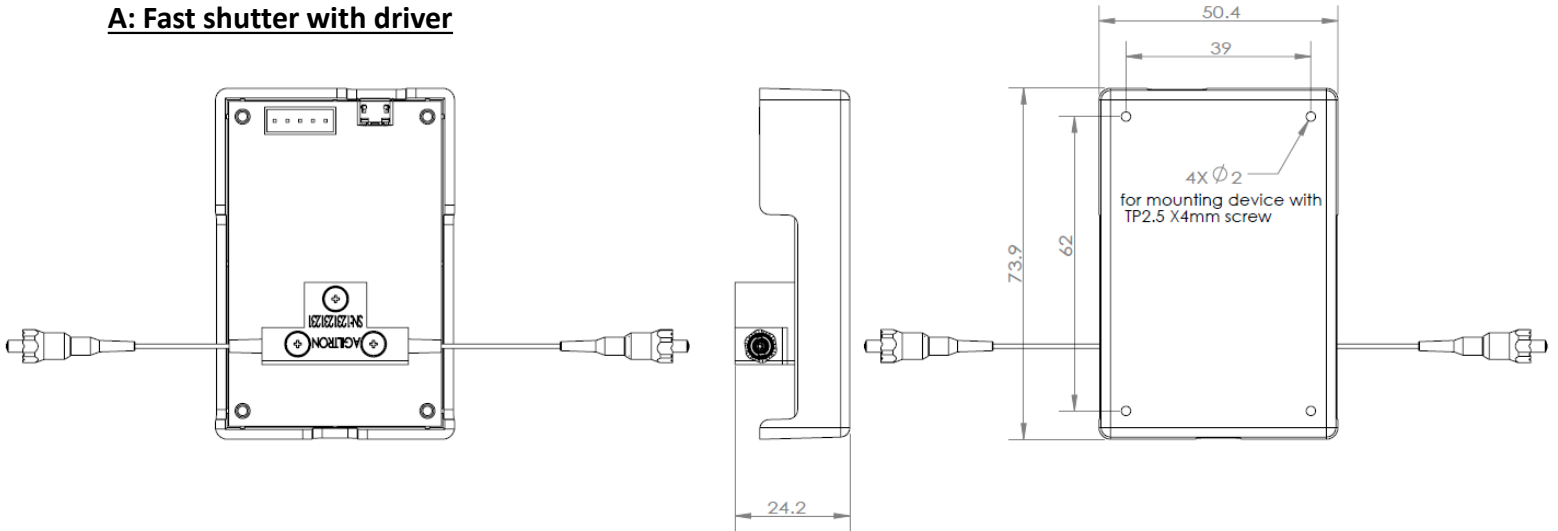

B: Fast shutter without driver

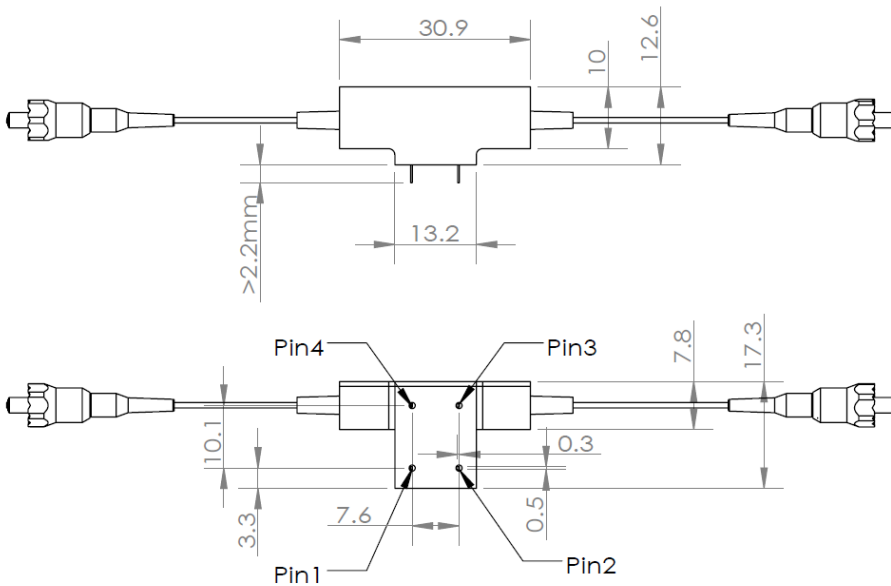

Optical Path	Electric Drive	
	Pin 1	Pin 2
Transparent (ON)	0 V	0 V
Opaque(OFF)	4.5 V	0 V

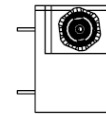

*Product dimensions may change without notice. This is sometimes required for non-standard specifications.

Broadband Fast Fiber Optical Shutter



(US patent 8,666,218 and other patents pending)

DATASHEET

Typical Response (SM28 Fiber, 0.4ms)

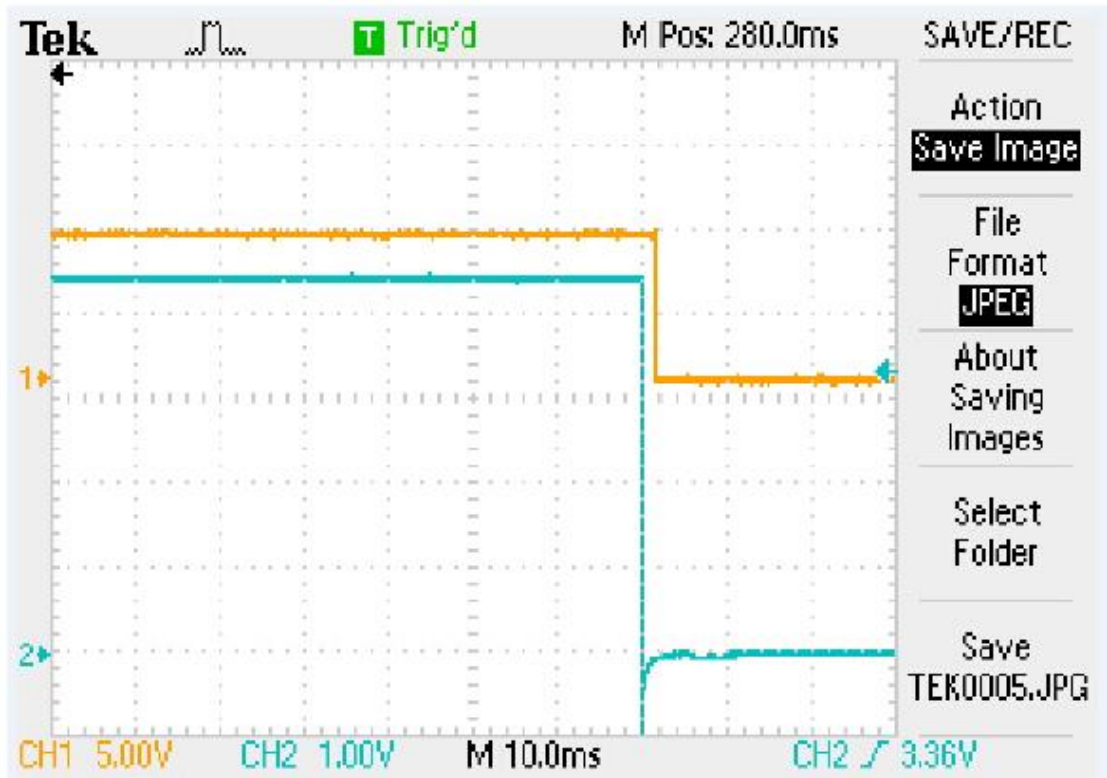

Notes:

bottom orange curve is optical response, Top blue curve is electrical signal
This device is normally transparent, the fall off can be used as shutter function.

Electrical Control Interface

The shutter is powered by a 5VDC through side plug or the underneath pins. A wall pluggable power supplier is shipped with the product. Please find it inside the package

The shutter is controlled by a 0-5 input signal though the underneath pins, or USB, or RS232

Broadband Fast Fiber Optical Shutter



(US patent 8,666,218 and other patents pending)

DATASHEET

Ordering Information

Prefix	Type	Controller	Test Wavelength	Fiber Type	Fiber Cover	Fiber Length	Connector *
FFST-	Relay = 2 Special = 0	0-5V = 55 USB/GUI/TTL = 56 None = 11 Special = 00	350 = U 488 = 4 532 = 5 630 = 6 780 = 7 850 = 8 980 = 9 1060 = 1 1310 = 3 1550 = C 2000 = 2	Select from the table below	900um tube=3 Bare fiber=1 Special=0	0.25m=1 0.5m=2 1.0m=3 Special=0	None=1 FC/PC=2 FC/APC=3 SC/PC=4 SC/APC=5 ST/PC=6 LC/PC=7 LC/APC = A LC/UPC = U Special=0

Fiber Type Selection Table:

01	SMF-28	34	PM1550	67	OM1 (MMF 62.5/125µm)
02	SMF-28e	35	PM1950	68	OM2 (MMF 50/125µm)
03	Corning XB	36	PM1310	69	OM3 (MMF 50/125µm)
04	SM450	37	PM400	70	OM4 (MMF 50/125µm)
05	SM1950	38	PM480	71	GIF50 (GIF 50/125µm)
06	SM600	39	PM630	72	GIF625 (GIF 62.5/125µm)
07	Hi780	40	PM850	73	105/125µm
08	SM800	41	PM980	74	FG105LCA
09	Hi980	42	PM780	75	FG50LGA
10	Hi1060	43		76	
11		44		77	
12		45		78	

Application Notes

Fiber Core Alignment

Note that the minimum attenuation for these devices depends on excellent core-to-core alignment when the connectors are mated. This is crucial for shorter wavelengths with smaller fiber core diameters that can increase the loss of many decibels above the specification if they are not perfectly aligned. Different vendors' connectors may not mate well with each other, especially for angled APC.

Fiber Cleanliness

Fibers with smaller core diameters (<5 µm) must be kept extremely clean, contamination at fiber-fiber interfaces, combined with the high optical power density, can lead to significant optical damage. This type of damage usually requires re-polishing or replacement of the connector.

Maximum Optical Input Power

Due to their small fiber core diameters for short wavelength and high photon energies, the damage thresholds for device is substantially reduced than the common 1550nm fiber. To avoid damage to the exposed fiber end faces and internal components, the optical input power should never exceed 20 mW for wavelengths shorter 650nm. We produce a special version to increase the handling by expanding the core side at the fiber ends.

Broadband Fast Fiber Optical Shutter



(US patent 8,666,218 and other patents pending)

DATASHEET

Electrical Connector Configurations

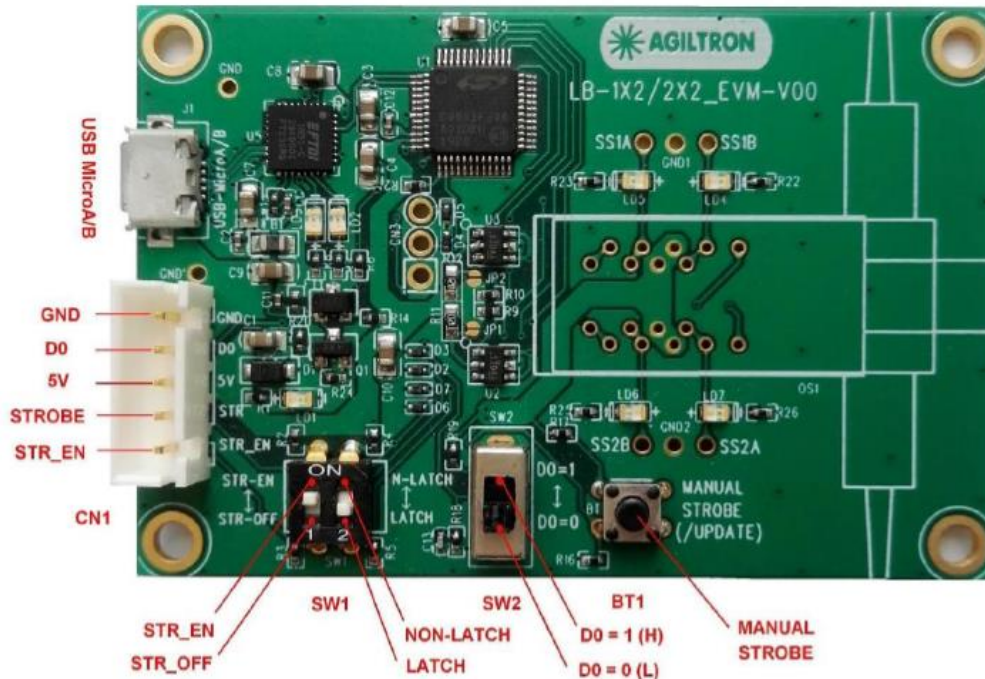

Power Voltage Input DC	Mini 4.9V	Max 5.2V
------------------------	-----------	----------

The two configuration switches S1 and S2 are present to match switch type. Do not change it.

Manual Operation Instruction

- **Power the Board**

The unit can be powered up via the Micro USB port connecting to a computer or a cellphone wall plug power supply.

- **Manual Push Button Control**

When using Manual Push Button Control, SW1-1 should be set to **STR_EN**.

Once the board is powered (LED on), the unit can be easily controlled by pushing the **STROBE** button, the light path will be changed accordingly.

TTL Operation Instruction

- **Power the Board**

The unit can be powered up via the Micro USB port connecting to a computer or a cellphone wall plug power supply.

- **TTL Control**

When using TTL Control, SW1-1 should be set to **STR_OFF**.

The unit can be controlled by a standard TTL Signal. Sending a **HIGH** voltage (>3.5V <5V) to the **D0** pin in the 5 pin connector, and the light path will change. Sending a **LOW** voltage (0-0.8V) to the **D0** pin in the 5 pin connector light path will change again.

Broadband Fast Fiber Optical Shutter



(US patent 8,666,218 and other patents pending)

DATASHEET

Computer Graphic Software User Guide

- **Install the Program**

Click on **setup.exe** for the automatic installation, which should be provided with the product.

- **Power and Connect the Board**

Use the Micro-USB to USB cable to connect the board with the PC with software installed. Remember to set SW1-1 to **STR_EN**.

- **Run the Program**

Run the "**Switch Operation Program.exe**" and the program will open the configuration window. Select the correct Switch Group and select the specific Switch Type. Then click the "Connect" button and the program will establish the connection between PC and board.

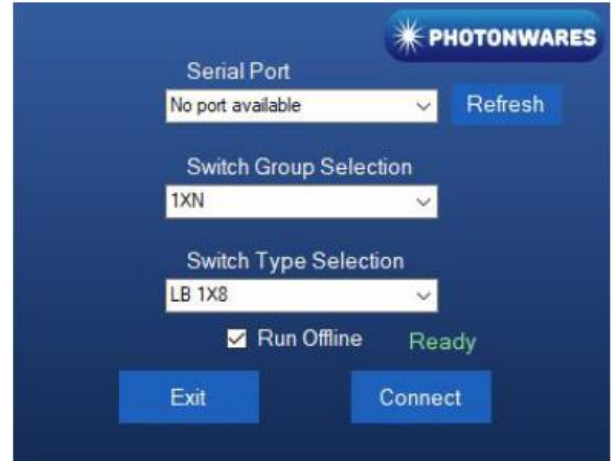

- **Create and edit testing time sequence**

Add step: Click the "Add Step" button in the menu strip or click the "+(ADD)" button would both add a step to the Programmable Running Sheet.

Delete step: Click the "Delete Step" button in the menu strip or click the "-(DEL)" button would both delete a step in the Programmable Running Sheet.



Broadband Fast Fiber Optical Shutter



(US patent 8,666,218 and other patents pending)

DATASHEET

Computer Graphic Software User Guide (continue)

Edit step: There are two things that you can modify for one step. One is the light path, and the other is the duration for each step. Double click the cell that you want to modify, and the program will allow you to modify the setting.

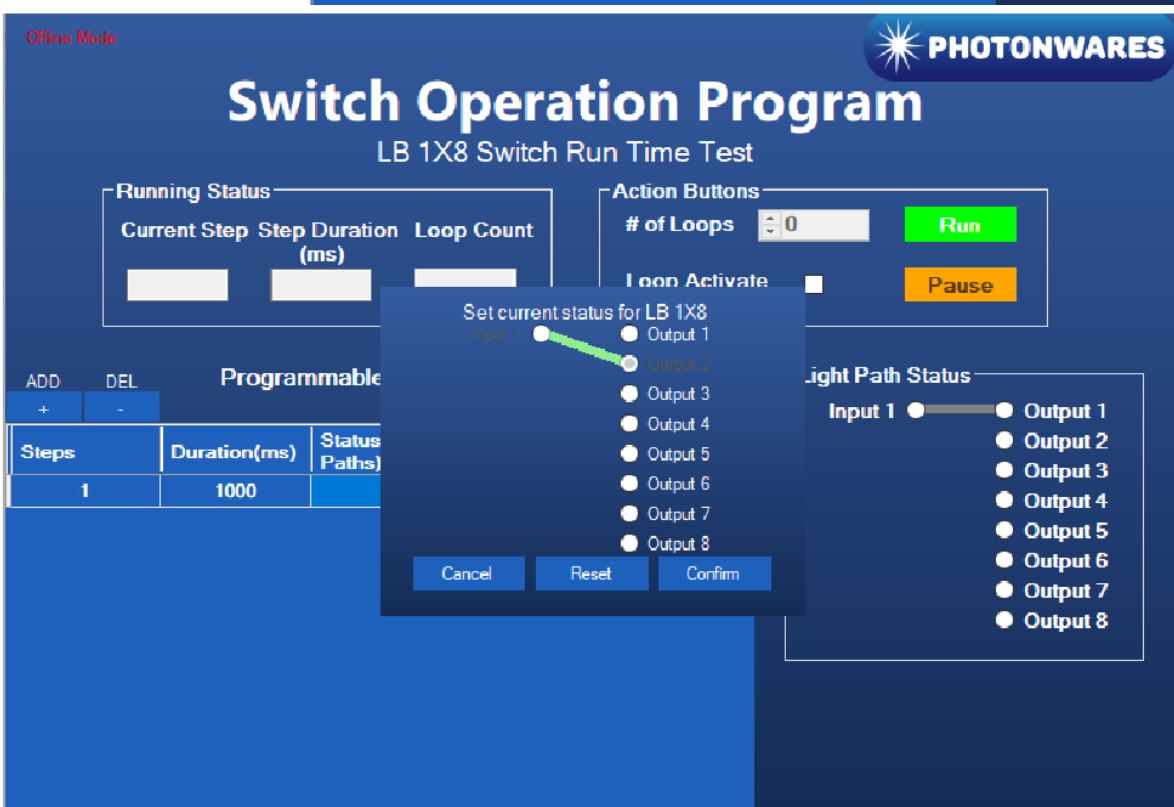
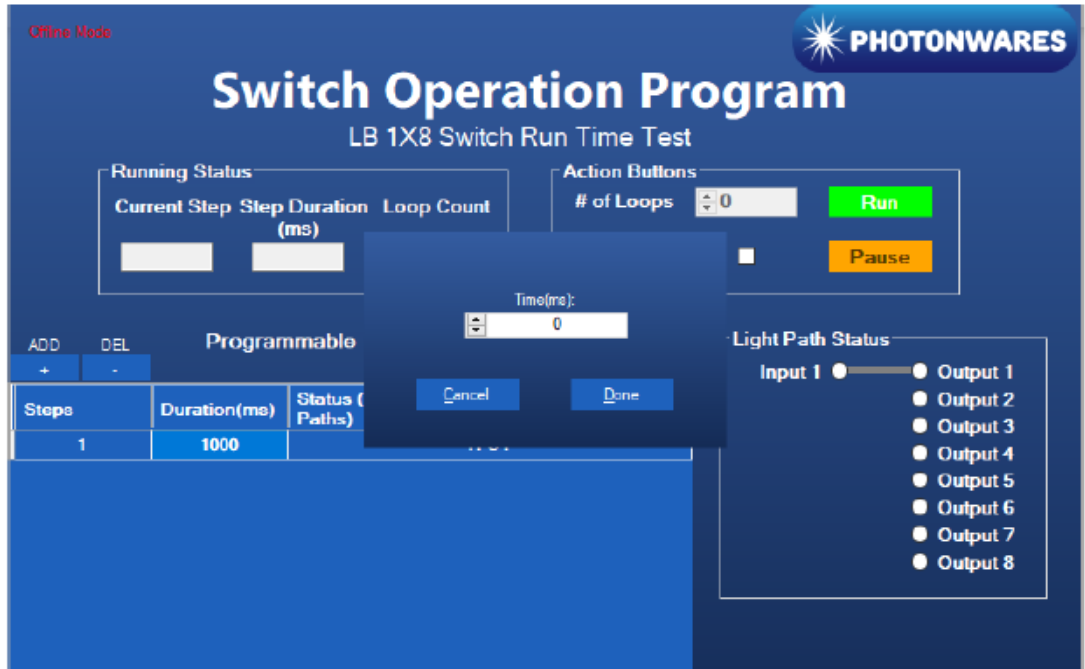

Broadband Fast Fiber Optical Shutter



(US patent 8,666,218 and other patents pending)

DATASHEET

Computer Interface Options

The USB interface working as a Virtual COM port which is compatible with LabView, Matlab. We provide **LabView** and **Matlab** interface software at extra cost.

A Windows GUI and UART command list will be provided for test and software development.

Command List

Command in Serial

The serial communication should be set in **9600 baud rate, none parity, 8 data bits, 1 stop bits.**

```
0x01 0x12 0x00 0x01 ---- Switch to status 1
```

```
0x01 0x12 0x00 0x02 ---- Switch to status 2
```

In **Matalb**,

Example code as below:

```
s=serialport("COM1", 9600, "Timeout", 5);
```

```
Write(s, [1, 18, 0, 1], "uint8");
```

```
for status 1
```

```
Write(s, [1, 18, 0, 2], "uint8");
```

```
for status 2
```